

## STANDARD SHAPES

EFFECTIVE: January 14, 2002

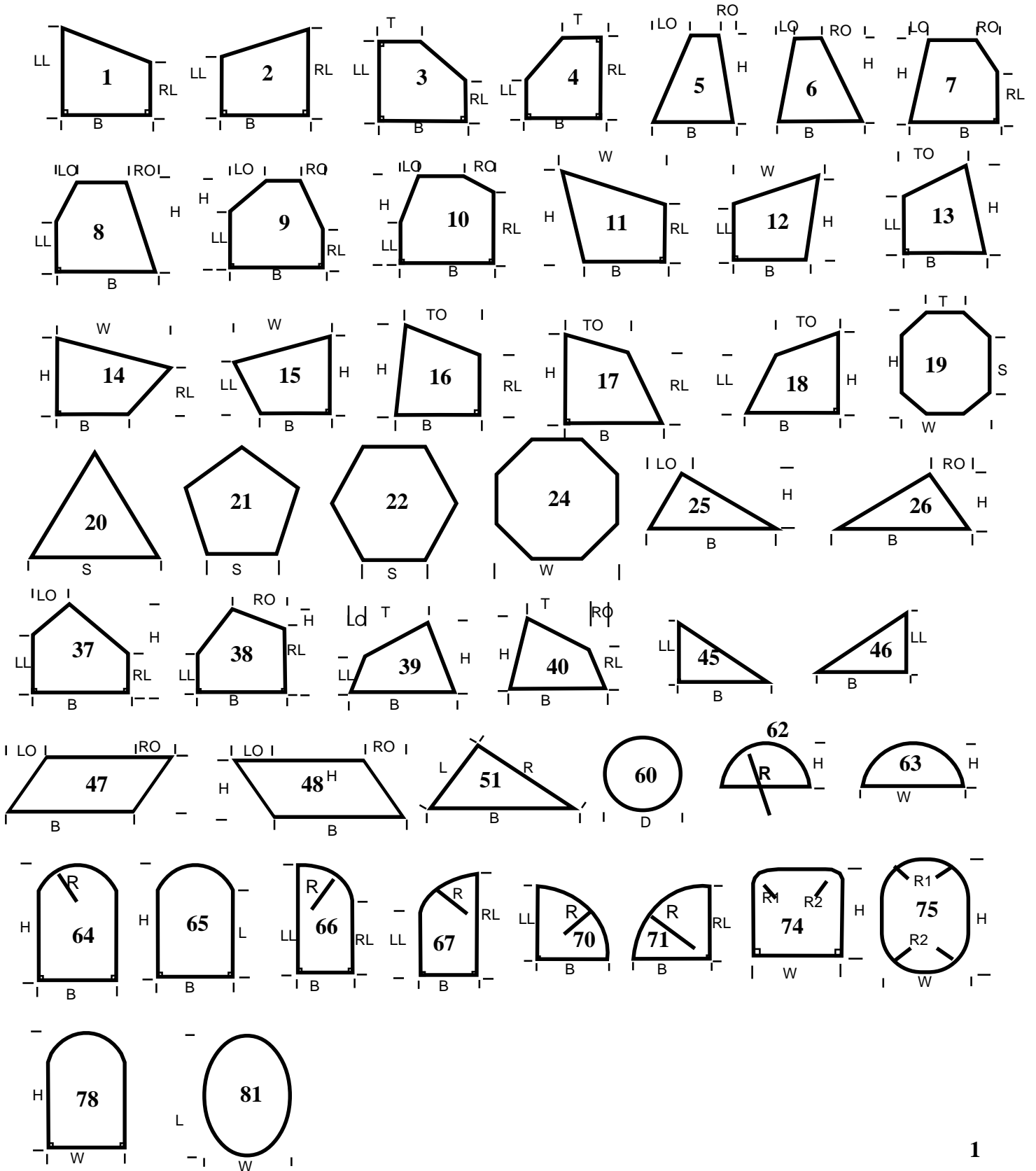

**SHAPE CATALOG**

**shape #1**  
gable right hand

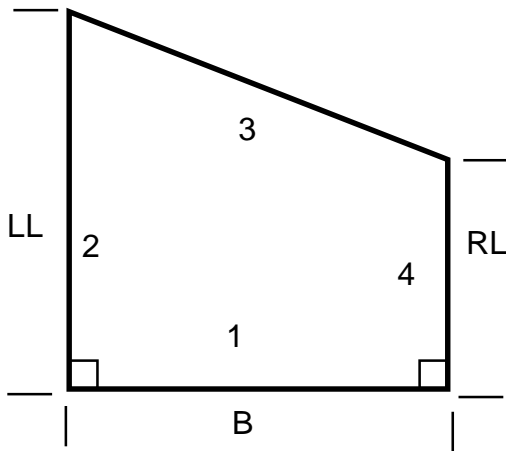

B \_\_\_\_\_

LL \_\_\_\_\_

RL \_\_\_\_\_

**shape #2**  
gable left hand

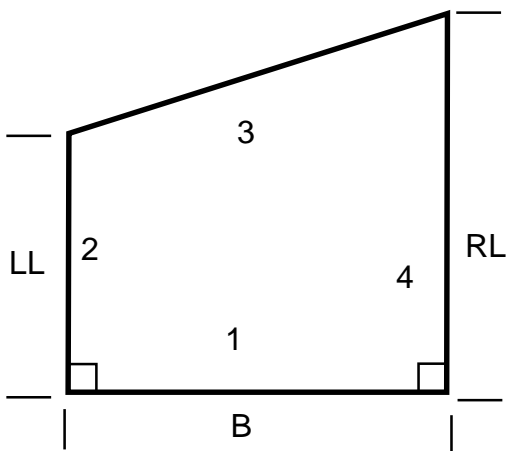

B \_\_\_\_\_

LL \_\_\_\_\_

RL \_\_\_\_\_

**SHAPE CATALOG**

**shape #3**

angle corner right hand

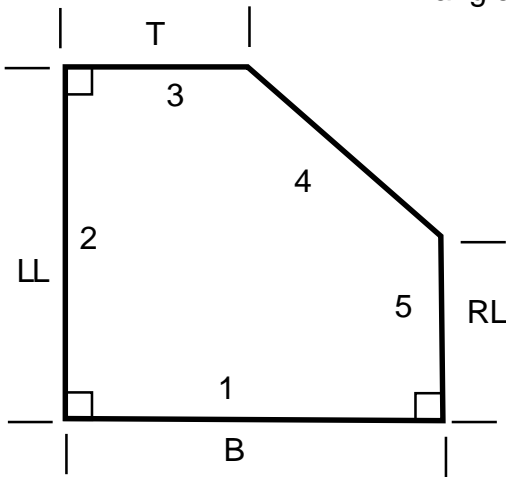

B \_\_\_\_\_

LL \_\_\_\_\_

RL \_\_\_\_\_

T \_\_\_\_\_

**shape #4**

angle corner left hand

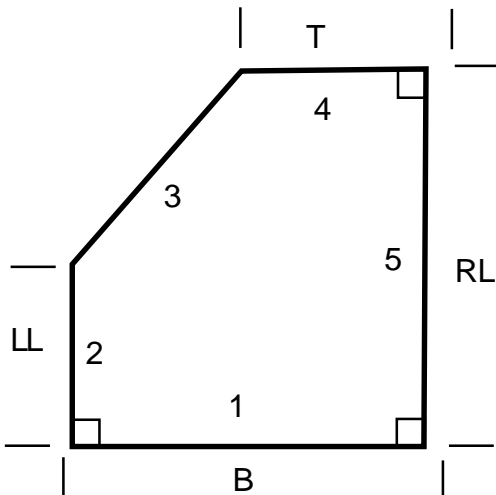

B \_\_\_\_\_

LL \_\_\_\_\_

RL \_\_\_\_\_

T \_\_\_\_\_

**SHAPE CATALOG**

**shape #5**

TRAPEZOID RH

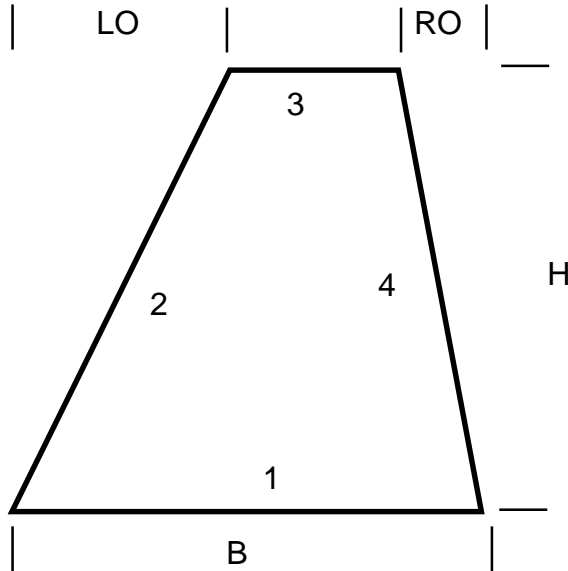

B \_\_\_\_\_  
H \_\_\_\_\_  
LO \_\_\_\_\_  
RO \_\_\_\_\_

**shape #6**

TRAPEZOID LH

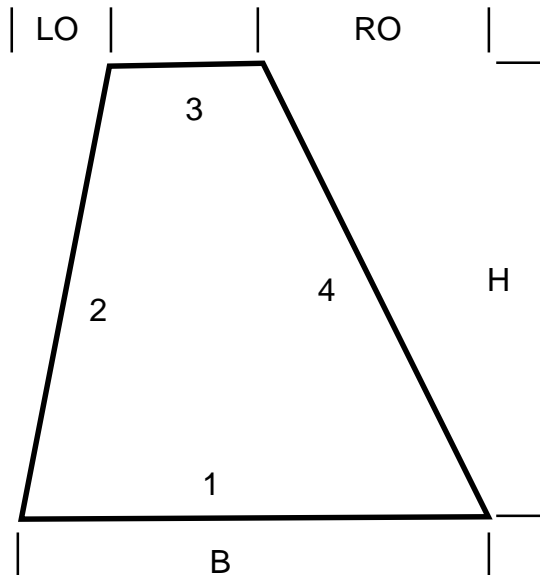

B \_\_\_\_\_  
H \_\_\_\_\_  
LO \_\_\_\_\_  
RO \_\_\_\_\_

**SHAPE CATALOG**

**shape #7**

IRREGULAR TRAPEZOID RH

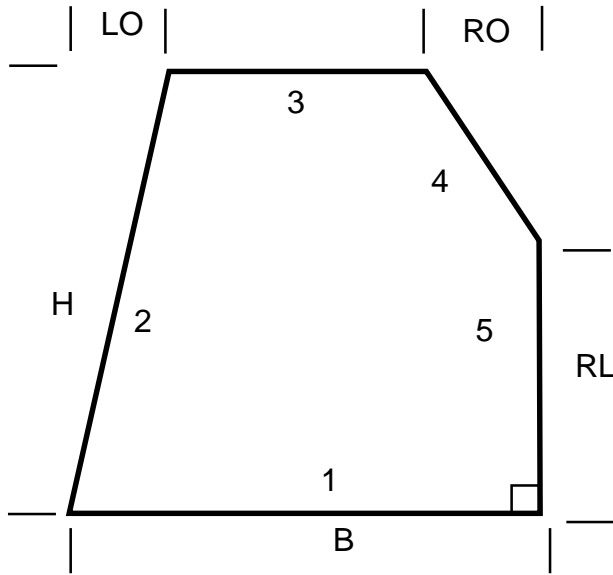

- B \_\_\_\_\_
- H \_\_\_\_\_
- RL \_\_\_\_\_
- LO \_\_\_\_\_
- RO \_\_\_\_\_

**shape #8**

IRREGULAR TRAPEZOID LH

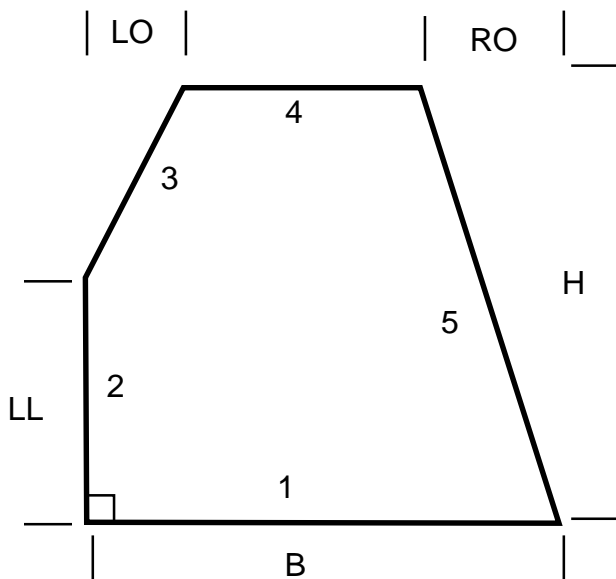

- B \_\_\_\_\_
- LL \_\_\_\_\_
- H \_\_\_\_\_
- LO \_\_\_\_\_
- RO \_\_\_\_\_

**SHAPE CATALOG**

**shape #9**

2 ANGLE CRN RH

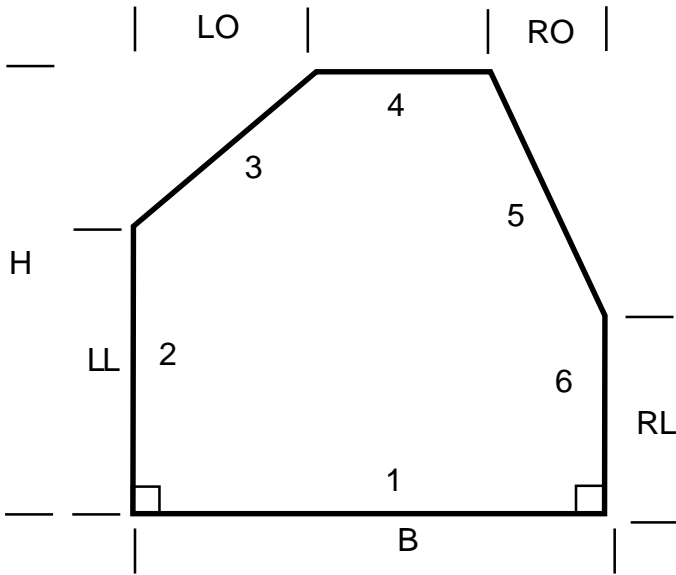

B \_\_\_\_\_  
H \_\_\_\_\_  
LL \_\_\_\_\_  
RL \_\_\_\_\_  
LO \_\_\_\_\_  
RO \_\_\_\_\_

**shape #10**

2 ANGLE CRN LH

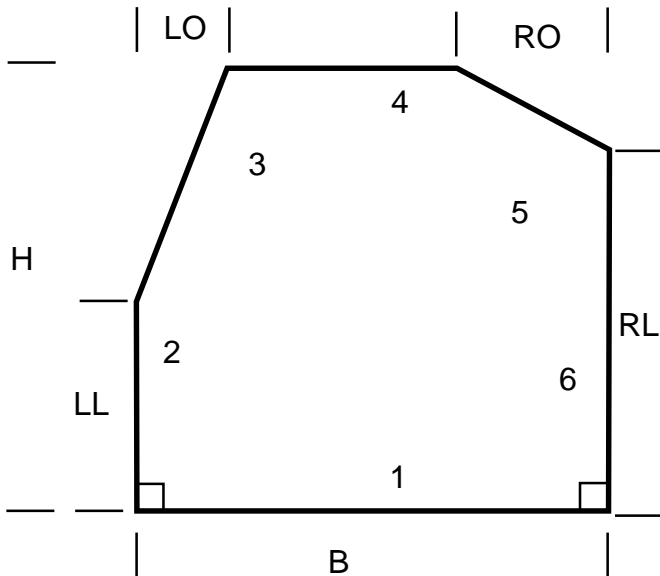

B \_\_\_\_\_  
H \_\_\_\_\_  
LL \_\_\_\_\_  
RL \_\_\_\_\_  
LO \_\_\_\_\_  
RO \_\_\_\_\_

**SHAPE CATALOG**

**shape #11**  
IRREGULAR GABLE RH

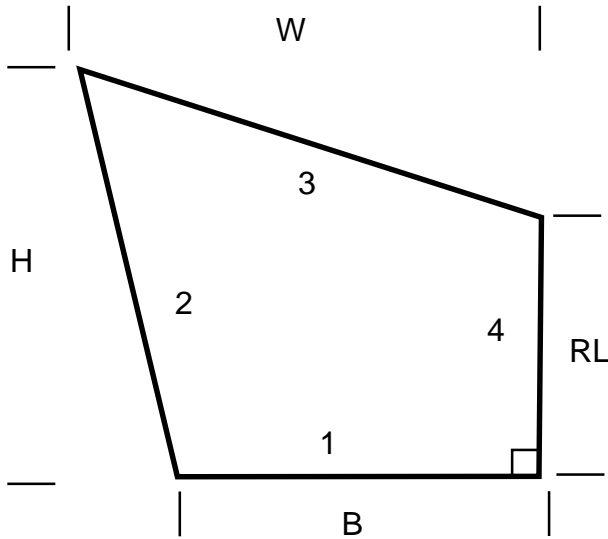

B \_\_\_\_\_  
H \_\_\_\_\_  
RL \_\_\_\_\_  
W \_\_\_\_\_

**shape #12**  
IRREGULAR GABLE LH

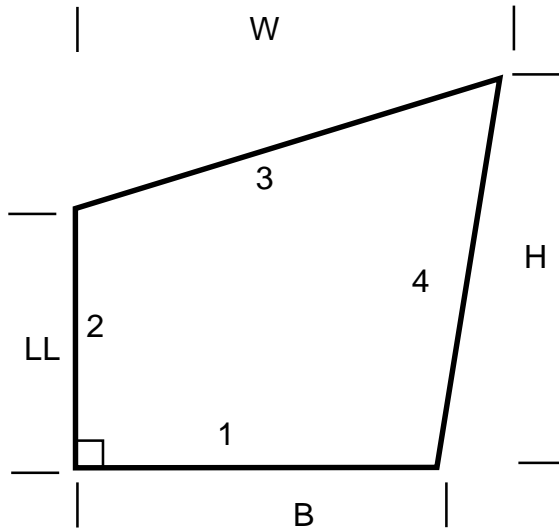

B \_\_\_\_\_  
LL \_\_\_\_\_  
H \_\_\_\_\_  
W \_\_\_\_\_

**SHAPE CATALOG**

**shape #13**

IRREGULAR GABLE LH

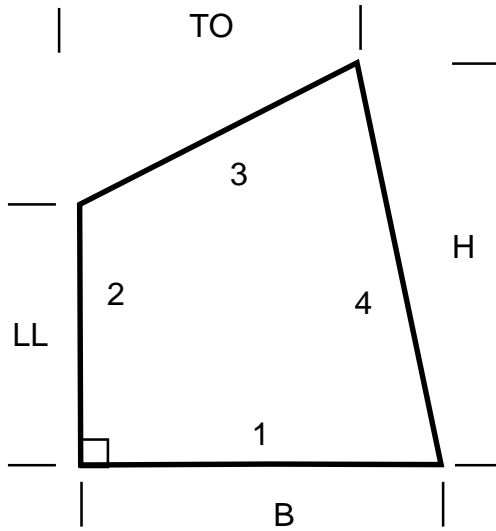

B \_\_\_\_\_  
LL \_\_\_\_\_  
H \_\_\_\_\_  
TO \_\_\_\_\_

**shape #16**

IRREGULAR GABLE RH

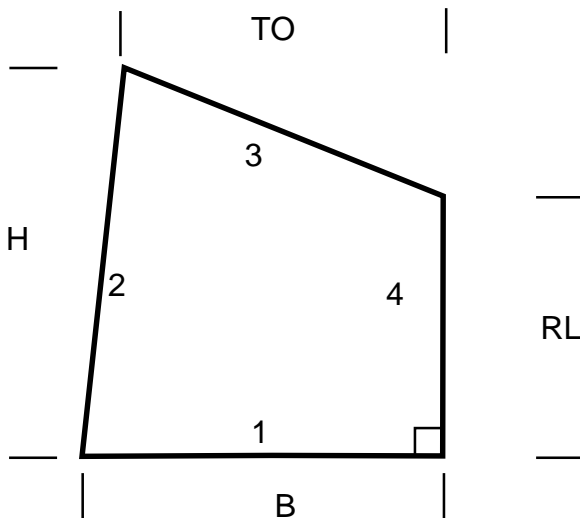

B \_\_\_\_\_  
H \_\_\_\_\_  
RL \_\_\_\_\_  
TO \_\_\_\_\_



**SHAPE CATALOG**

**shape #14**

IRREGULAR GABLE RH

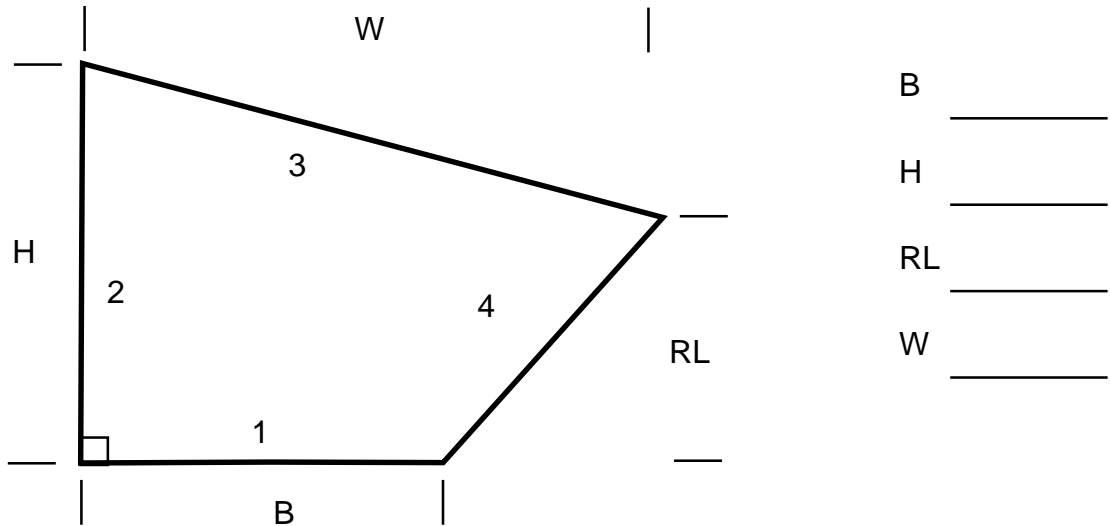

**shape #15**

IRREGULAR GABLE LH

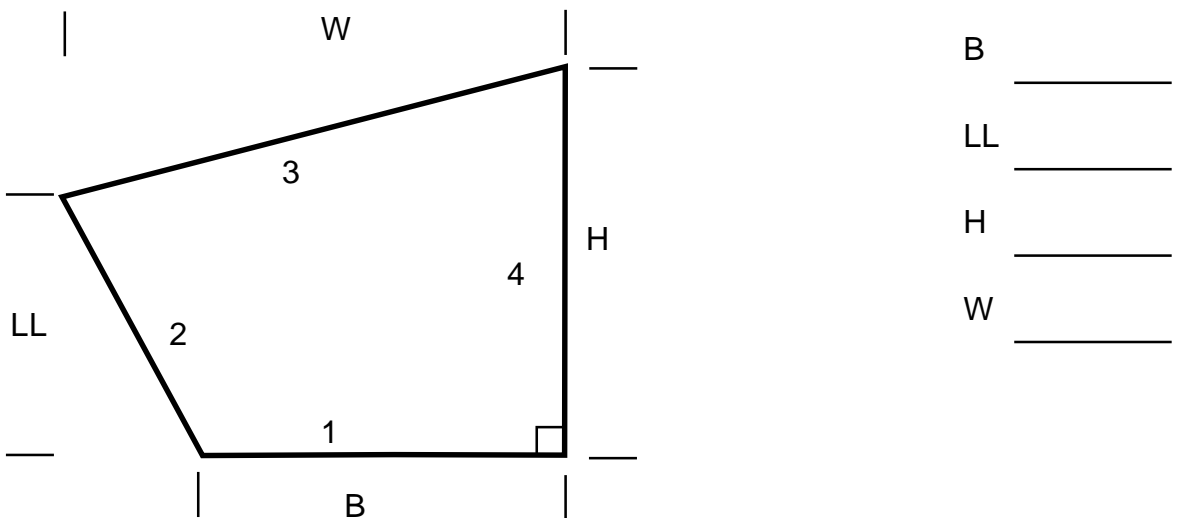

**SHAPE CATALOG**

**shape #17**  
IRREGULAR GABLE RH

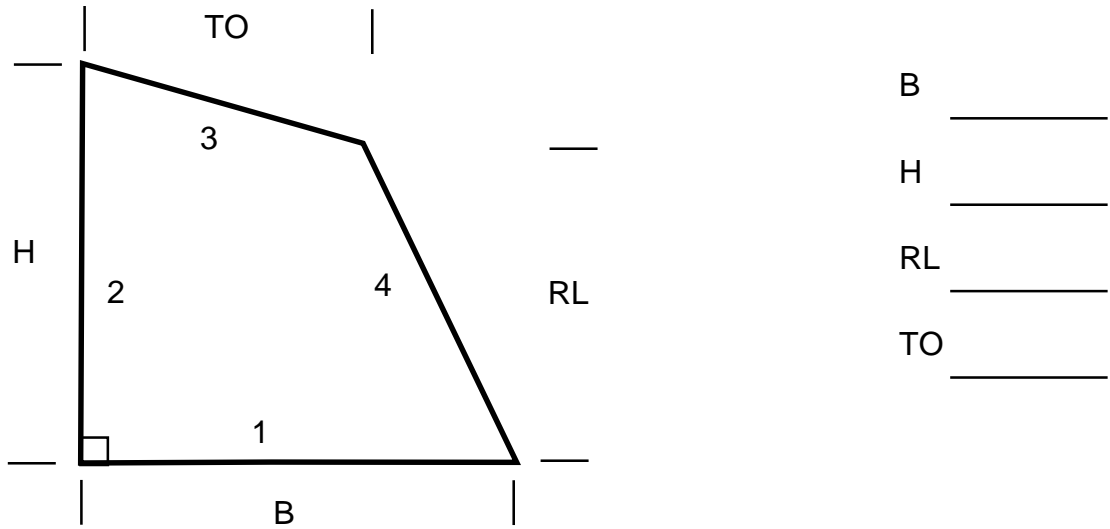

**shape #18**  
IRREGULAR GABLE LH

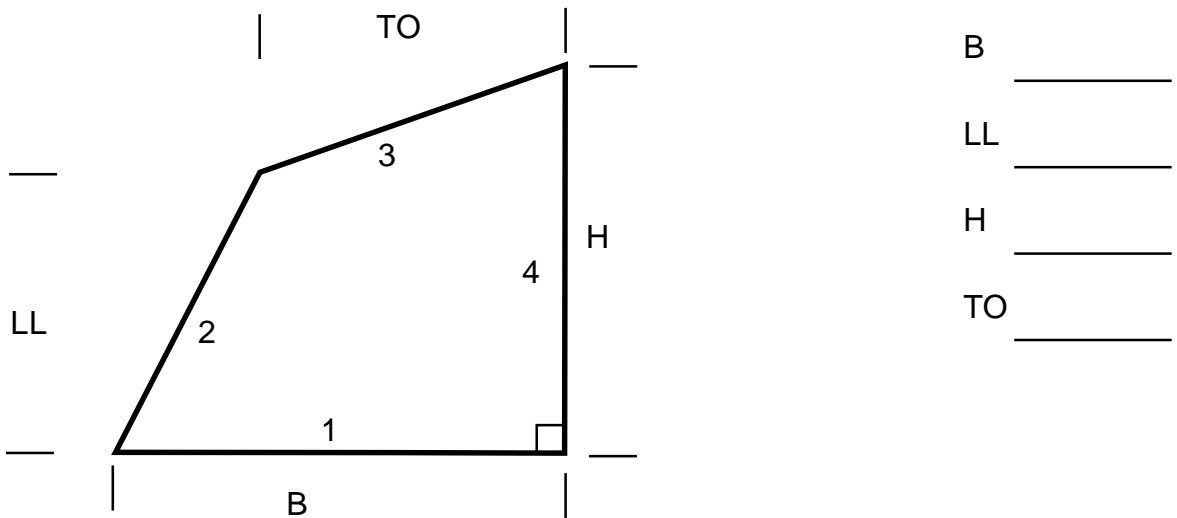

**SHAPE CATALOG**

**shape #19**  
OCTAGON

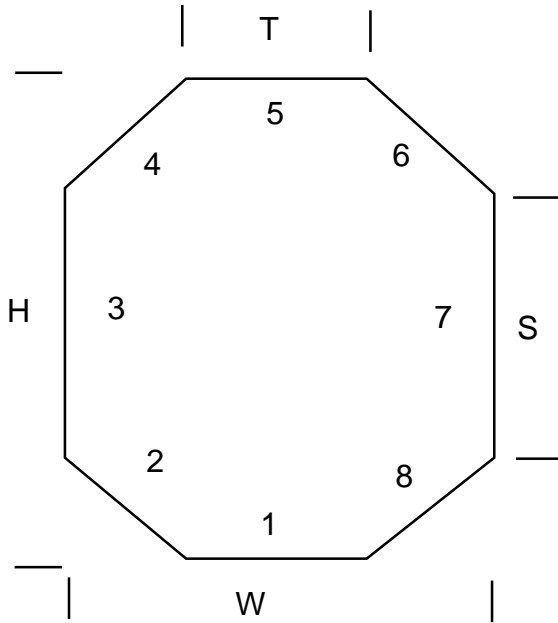

W \_\_\_\_\_  
H \_\_\_\_\_  
S \_\_\_\_\_  
T \_\_\_\_\_

**shape #20**  
EQUAL TRIANGLE

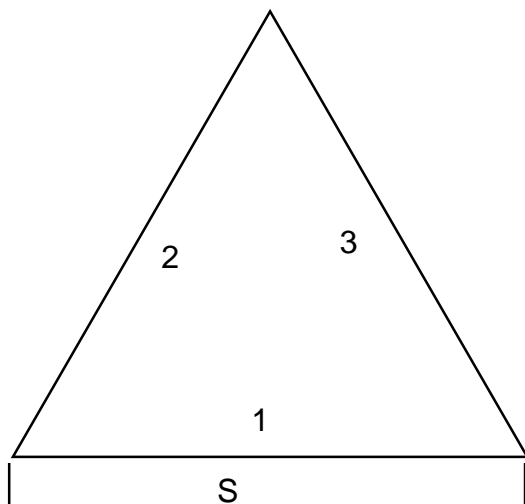

S \_\_\_\_\_

**SHAPE CATALOG**

**shape #21**  
REGULAR PENTAGON

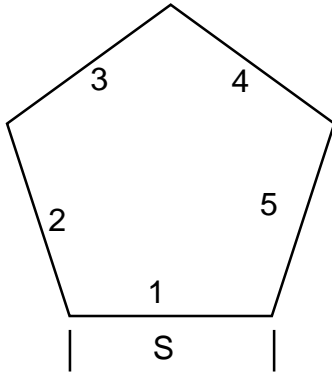

S \_\_\_\_\_

---

**shape #22**  
REGULAR HEXAGON

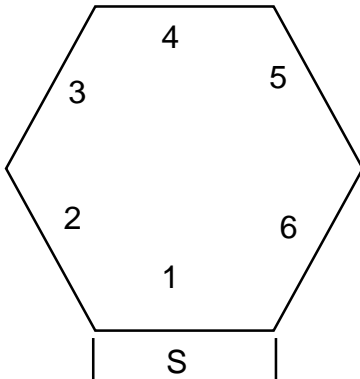

S \_\_\_\_\_

---

**shape #24**  
REGULAR OCTAGON

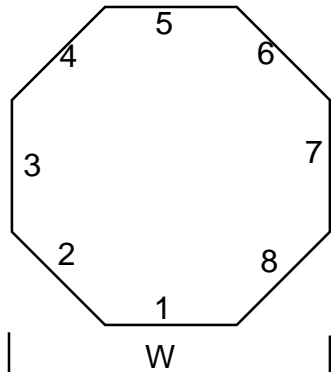

W \_\_\_\_\_

**SHAPE CATALOG**

**shape #25**  
TRIANGLE RH

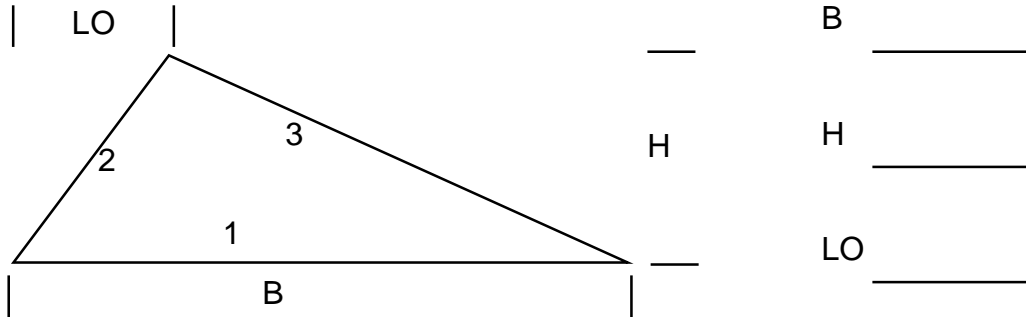

**shape #26**  
TRIANGLE LH

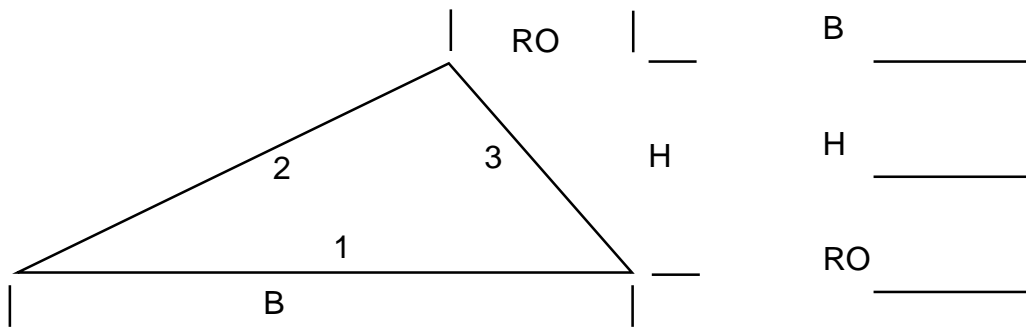

**shape #51**  
TRIANGLE GIVEN SIDES

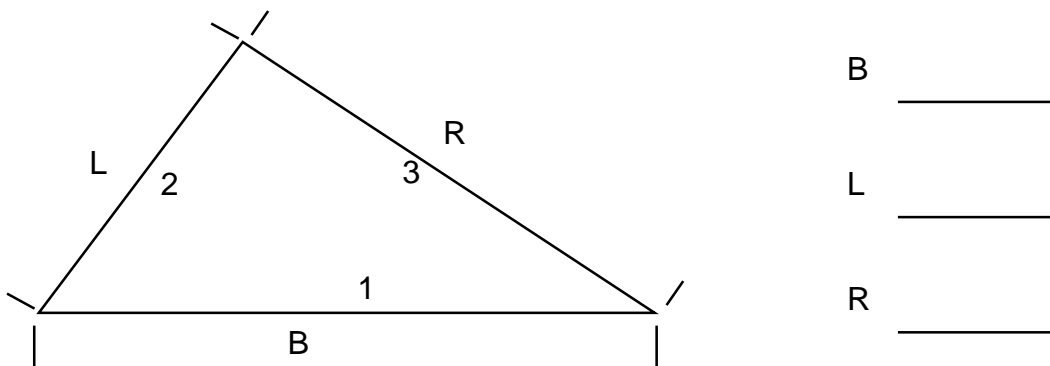

**SHAPE CATALOG**

**shape #37**  
DOG HOUSE RH

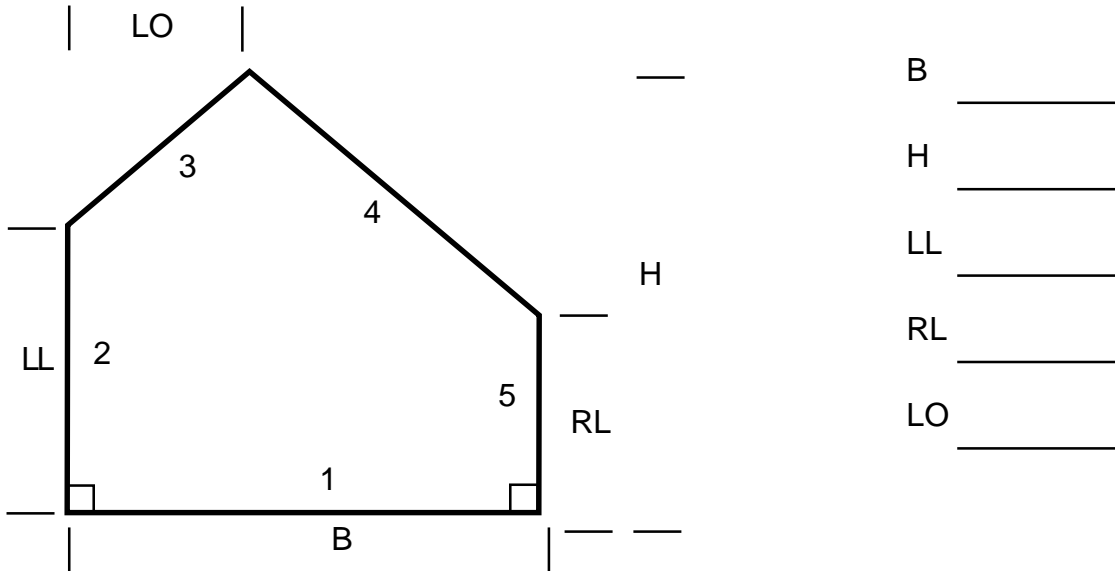

**shape #38**  
DOG HOUSE LH

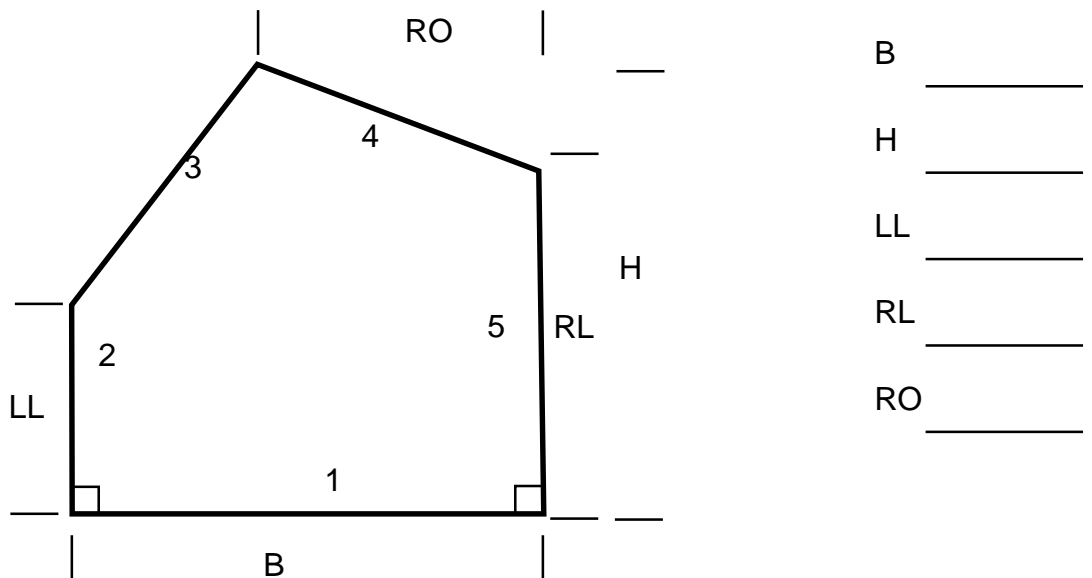

**SHAPE CATALOG**

**shape #39**  
IRREGULAR TRAPEZOID LH

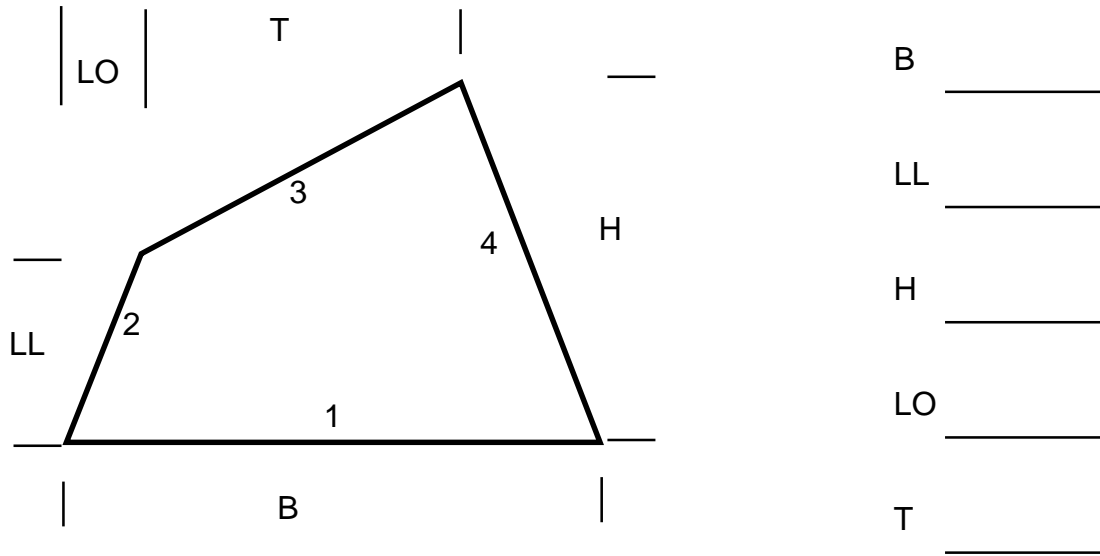

**shape #40**  
IRREGULAR TRAPEZOID LH

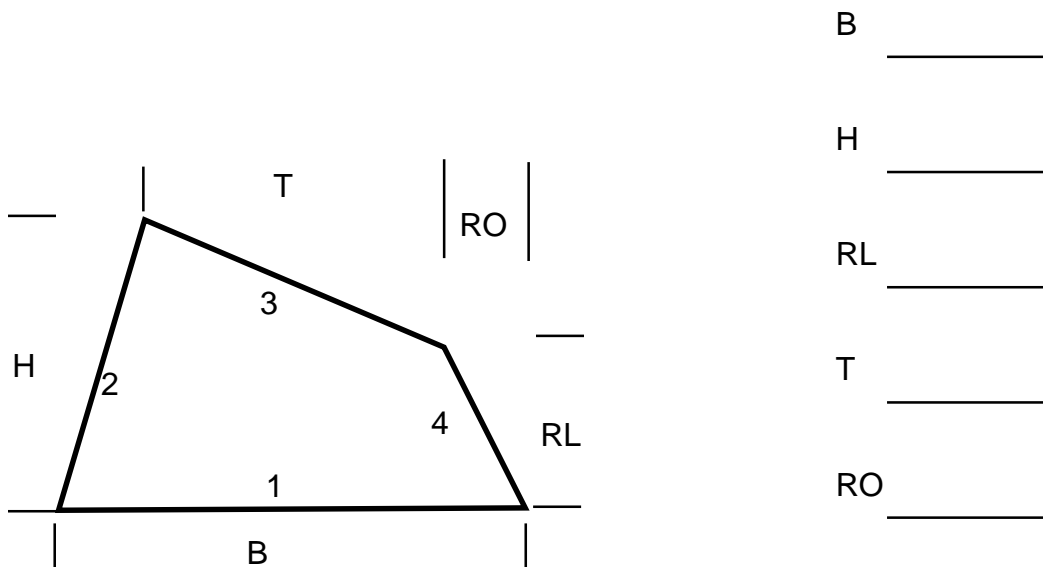

**SHAPE CATALOG**



**shape #45**  
RIGHT TRIANGLE RH

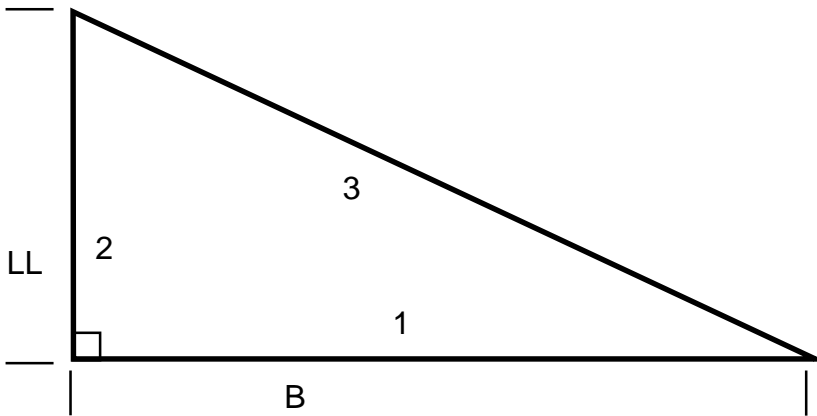

B \_\_\_\_\_

LL \_\_\_\_\_



**shape #46**  
RIGHT TRIANGLE LH

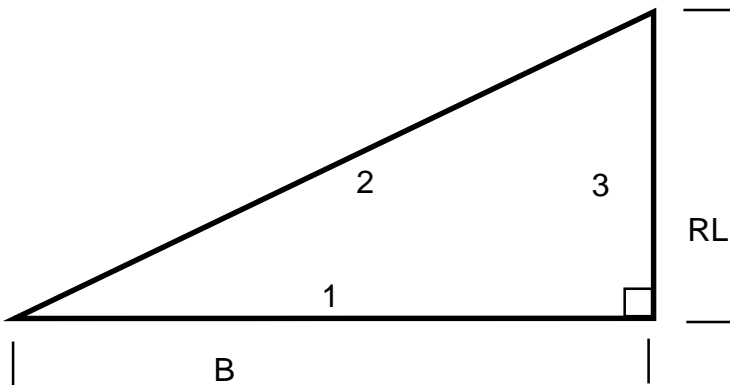

B \_\_\_\_\_

RL \_\_\_\_\_



**SHAPE CATALOG**

**shape #47**  
PARALLELOGRAM RH

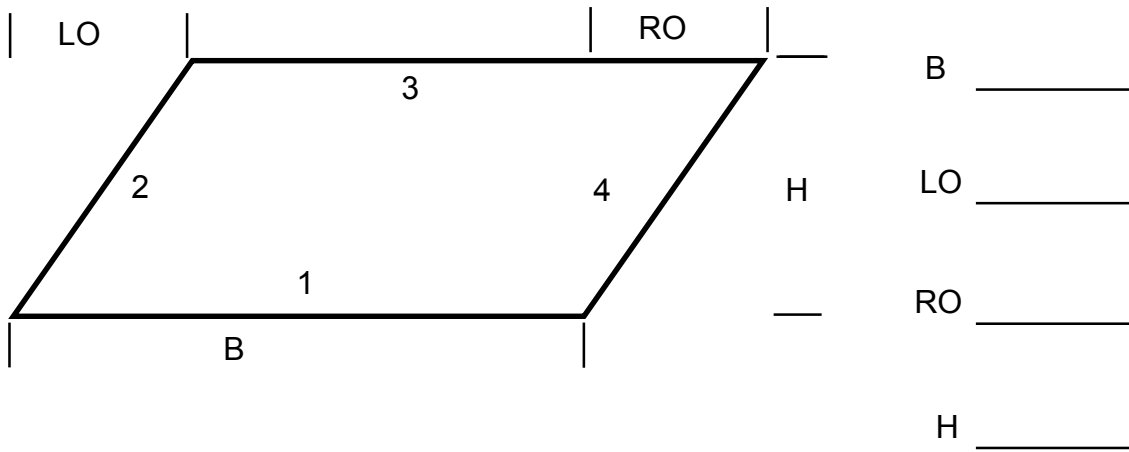

**shape #48**  
PARALLELOGRAM LH

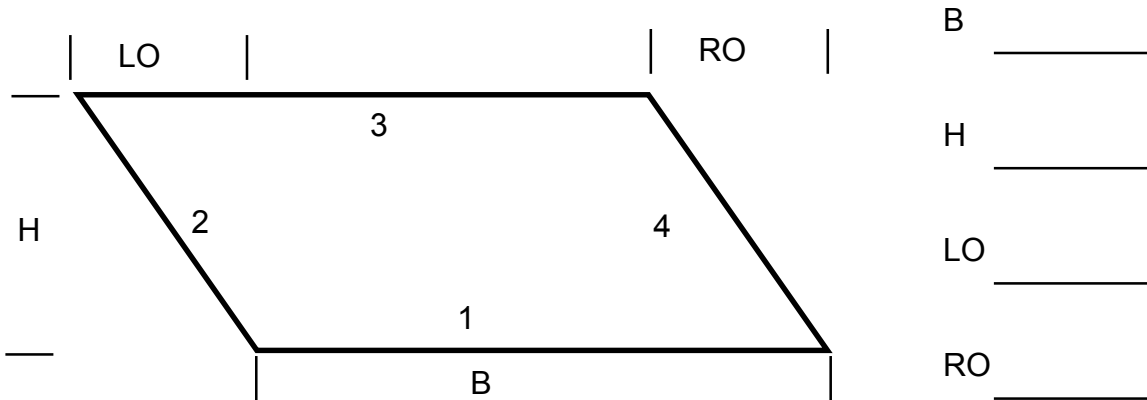

**SHAPE CATALOG**

**shape #60**  
CIRCLE

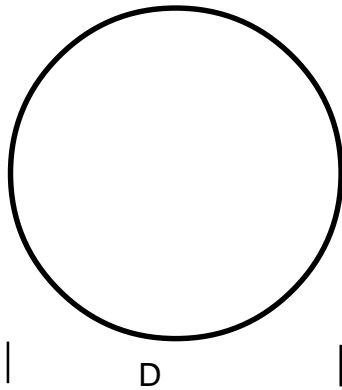

D \_\_\_\_\_

**shape #62**  
ARCH WITH RADIUS

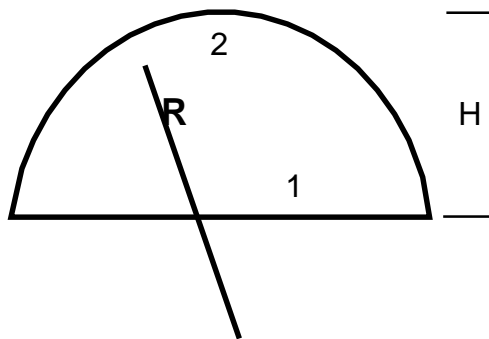

H \_\_\_\_\_

R \_\_\_\_\_

**shape #63**  
ARCH

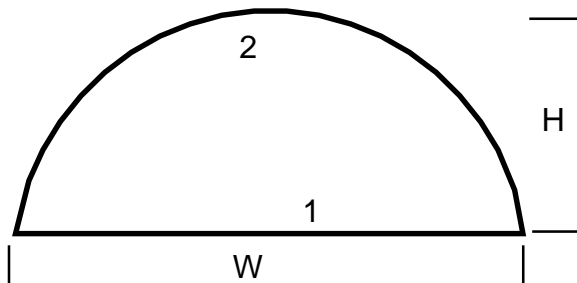

W \_\_\_\_\_

H \_\_\_\_\_



**SHAPE CATALOG**

**shape #64**

ARCH TOP WITH RADIUS

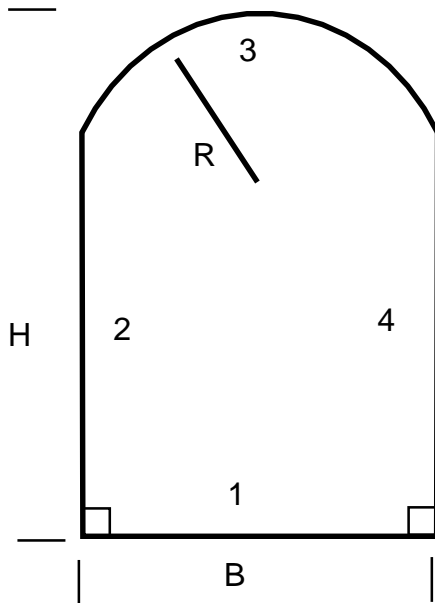

B \_\_\_\_\_  
H \_\_\_\_\_  
R \_\_\_\_\_



**shape #65**

ARCH TOP

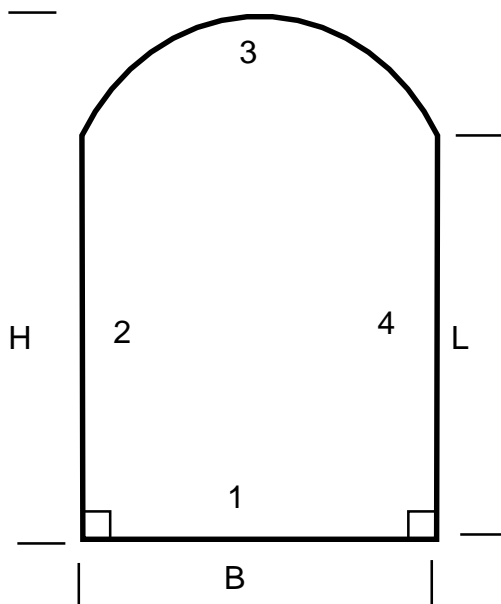

B \_\_\_\_\_  
H \_\_\_\_\_  
L \_\_\_\_\_

**SHAPE CATALOG**

**shape #66**  
ARCH GABLE RH

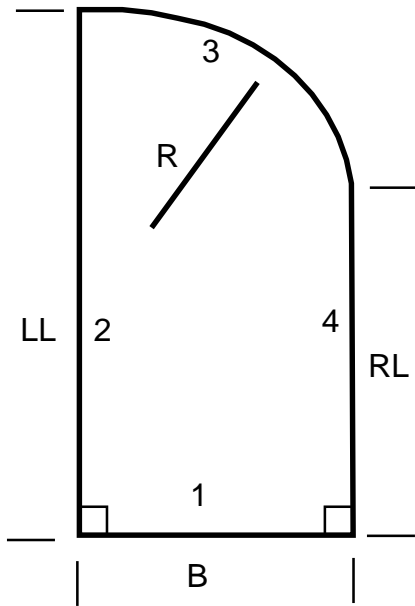

B \_\_\_\_\_  
LL \_\_\_\_\_  
RL \_\_\_\_\_  
R \_\_\_\_\_

**shape #67**  
ARCH GABLE LH

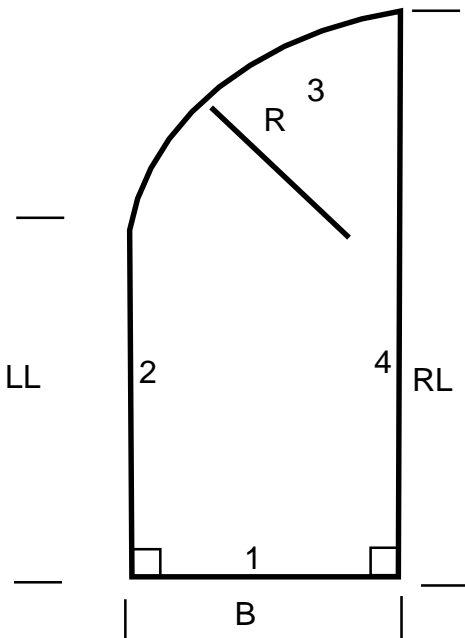

B \_\_\_\_\_  
LL \_\_\_\_\_  
RL \_\_\_\_\_  
R \_\_\_\_\_

**SHAPE CATALOG**

**shape #70**  
QUARTER ARCH RH

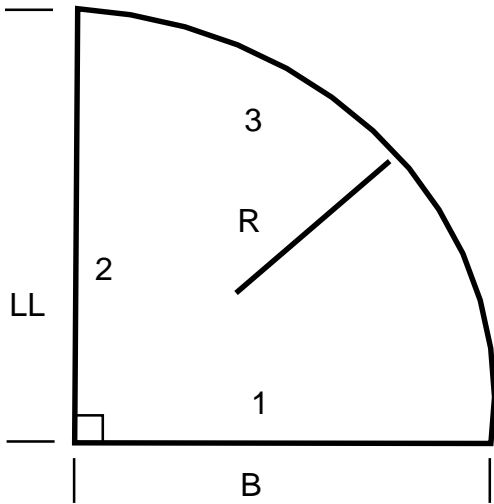

B \_\_\_\_\_  
LL \_\_\_\_\_  
R \_\_\_\_\_

**shape #71**  
QUARTER ARCH LH

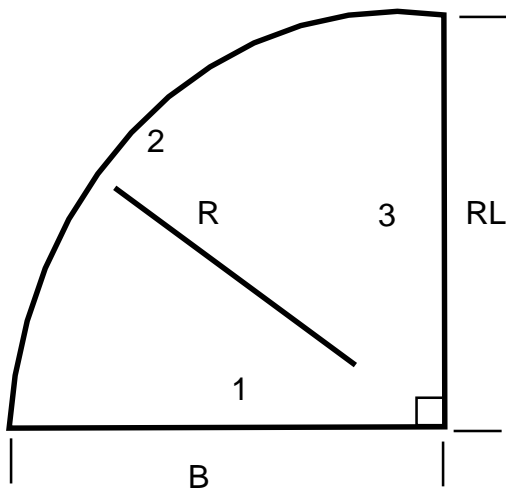

B \_\_\_\_\_  
RL \_\_\_\_\_  
R \_\_\_\_\_

## SHAPE CATALOG

**shape #74**  
 W/2 RADIUS CORNERS

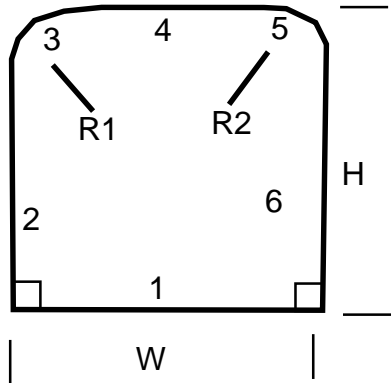

W \_\_\_\_\_

H \_\_\_\_\_

R1 \_\_\_\_\_

R2 \_\_\_\_\_

**shape #75**  
 RECTANGLE W/4 RADIUS CORNERS

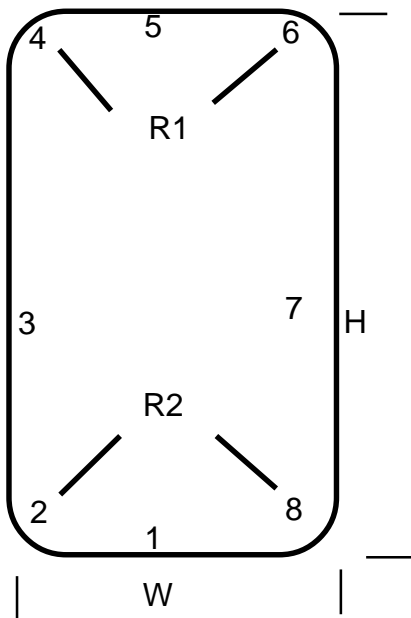

W \_\_\_\_\_

H \_\_\_\_\_

R1 \_\_\_\_\_

R2 \_\_\_\_\_

**SHAPE CATALOG**

**shape #78**  
ROUND TOP

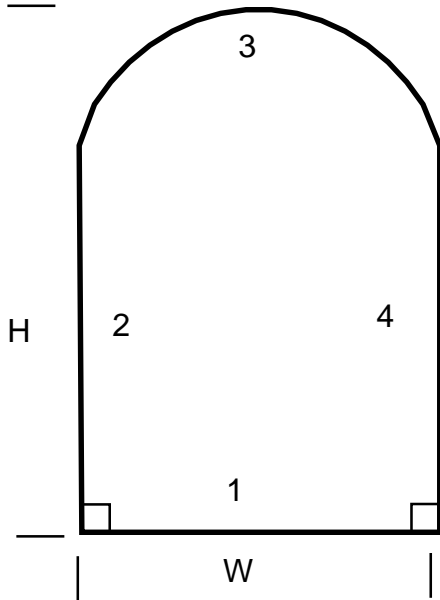

W \_\_\_\_\_

H \_\_\_\_\_

**shape #81**  
ELLIPSE

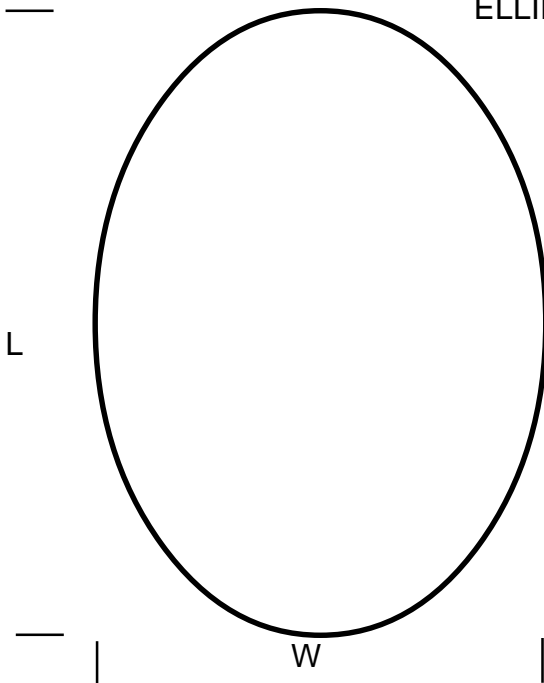

W \_\_\_\_\_

L \_\_\_\_\_